

EX. REISS.
 1. Tables + strings +
 2. UIC + body so ps.
 3. up → 3 or 4.
 4. Just within earshot → goes into contraction of radi TV etc.
 5. on street cybers.
 6. MUSIC OF INTEGRATION & MUSICAL instrument.
 7. music analysis pitch dynamic sense texture etc. rhythm.
 8. TO VIBRO A. definition of MUSIC
 9. SIMILARITIES - DIRECT COMPARISONS
 10. AREAS OF MUSIC TO BE AREA LIKE AND WHAT THEY LIKE
 11. PLAIN AND VIBRO AND VIBRO

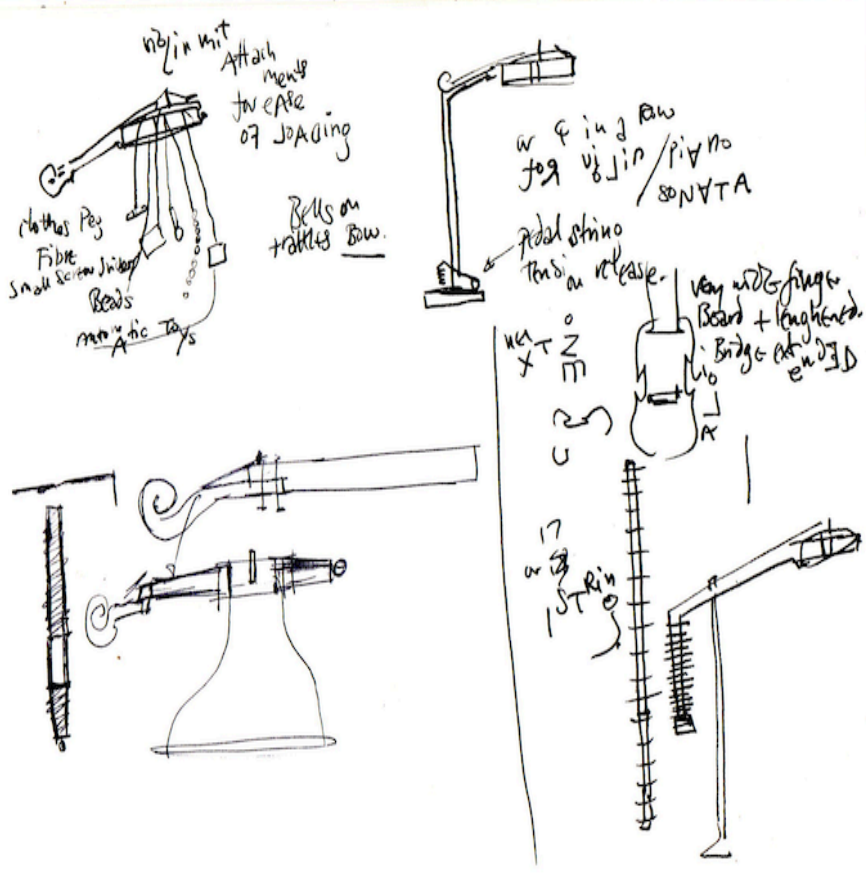

He'd do more if he could but the man doesn't know any more
 He'd like to play more, but that's all the man knows' EP.
 MARGIN WISELY COMPUTATION WITH IMPORTANCE of a some PREVIOUS back up MIT FAIRLIGHT.
 JAN ROSE
 violin
 standard for the violin.

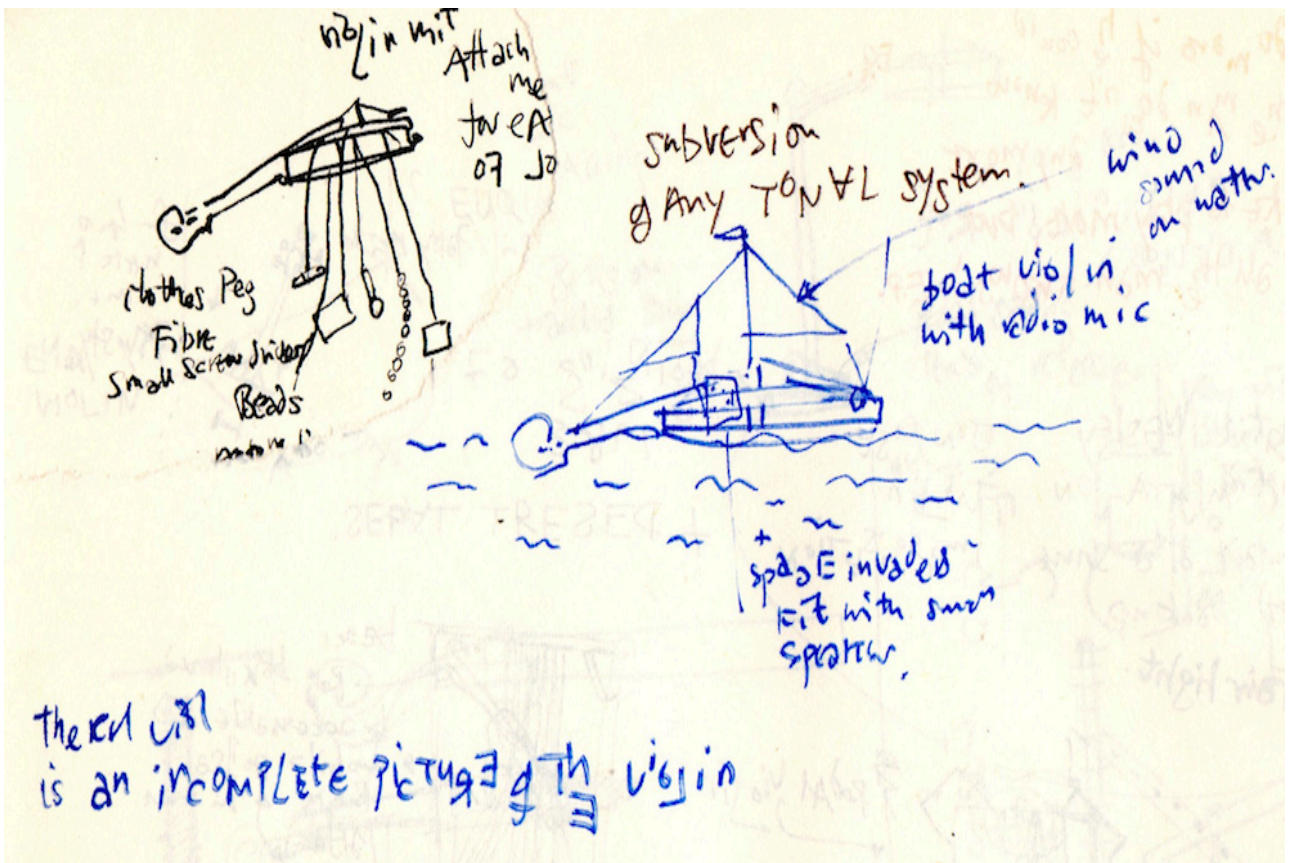

Thimo Pissis Jiggs for
16 STRINGS VIOLIN 8 COURSES

Left

Right

1 2 3 4 5 6 7 8
Bb G# F# Eb

The longest string
polystyrene resonator

by a tight steel wires.

1. violin lies in middle of a road
2. driver eventually runs over it
3. interview of driver.
4. interview of violin

Duo
Jence 2. Twin Lakes 1.



Slowing down the wheel.

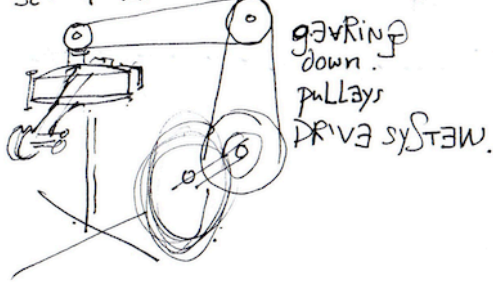

Janar Lab RAM battery check?

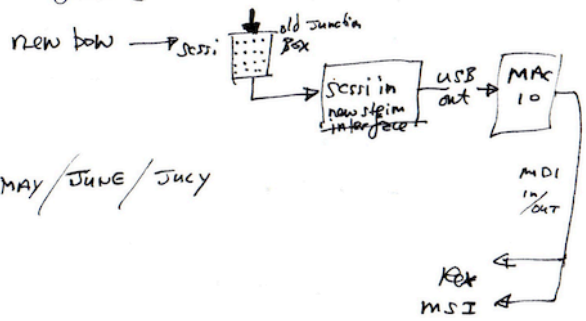

MAY/JUNE/JULY

PAGE I

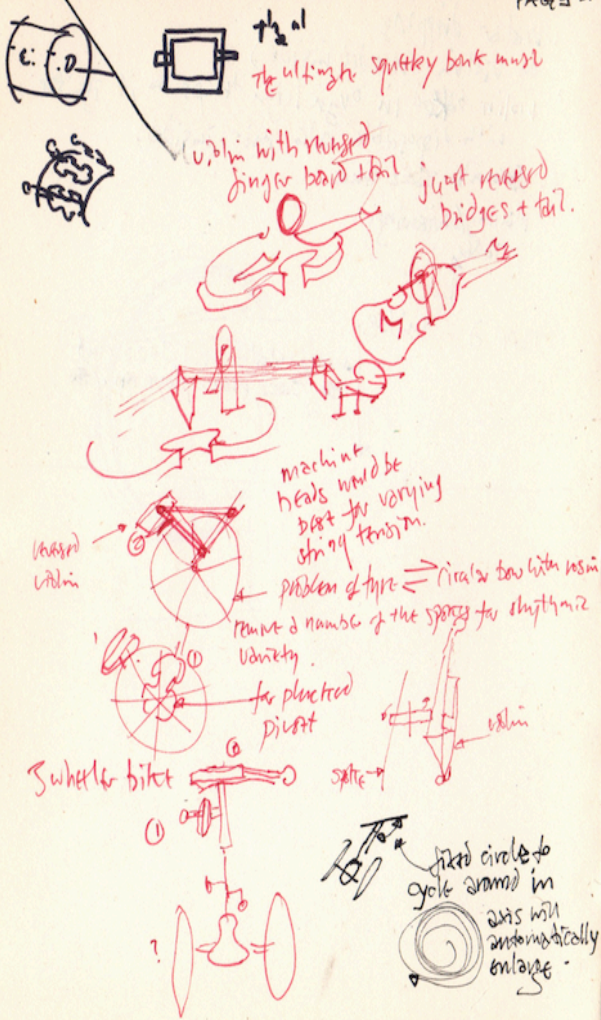

So in VIAGINE
MEAT IS SERVED
BACK TO FRONT
PLAY SOVIET OF THE COME APART

Begun Akhtar (voice) F
Thumri Mishra Tradi
(HMV-ECSP-2811)

the ultimate
back to front.
→ Jnan Pratosh Ghosh (harmonium)
→ V. Belsara (piano)
HMV-FA5D-1404

K.V. Narayanaswamy (voice) m.
with Dr. L. Subramaniam (vcln)
HMV-ECSD-3303

(was captured) as my
pronunciation for though
I was unable to say
anything intelligent.

unplay of making a good flying
Music - situation is sometimes
anything.

Al: Akhtar has A dam!
sitar

Travel Air India's and... can if you don't want

Exp: 1. B. Je. v. d.

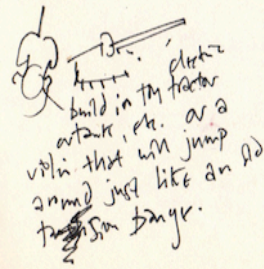

$K \sum_{N=1}^N \frac{1}{2^N} = 1$ or $\sum_{N=1}^{\infty} \frac{1}{2^N} = 1$

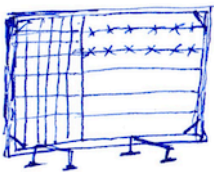
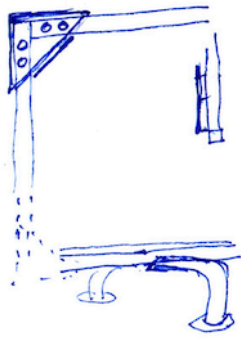

'Dend schereman'
The climate change
challenge + the failure
of Democracy.

or electric bass
guitar
machine feet

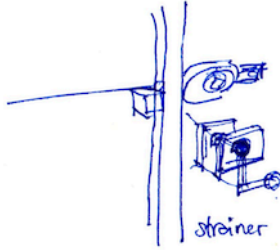

golden mean section

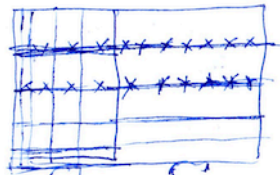
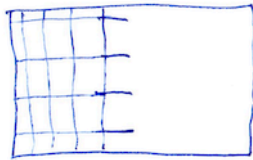

length of double bass string

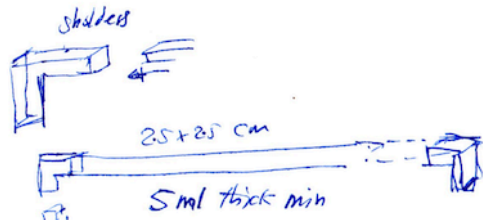

Smlr gauge.
And it's not ok!
Aluminium.

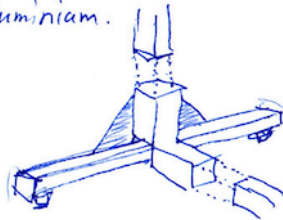

SWITE
CLARK
RUBBER
FOR
STOPPERS.

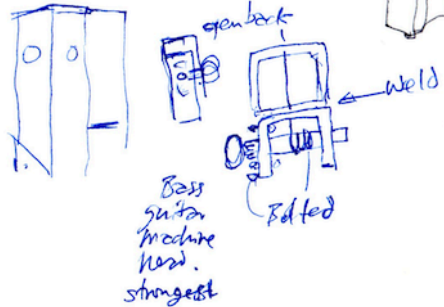

(Binnings)
clark rubber

KITE MUSIC

hummer



hummer
via FM contact mic

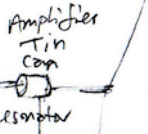

or plastic cup
amber smk. tube



Digger music
use mechani cal organ sounds!

bottom mixer → mic
↑
via contact mic

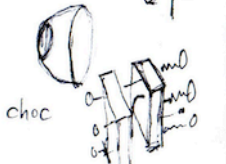

Additions: (A) Lip to pizzo
(B) Tuner

blocks 38x38x50 welded
to vertical members

